

# Data Sheet

## L770/840-40D54

Multi Wavelength LED Lamp

USHIO

### Outline and Internal Circuit

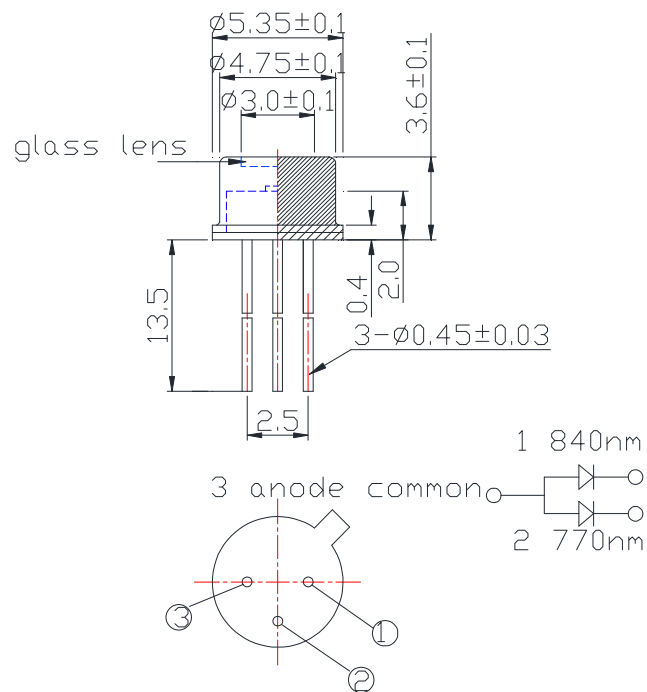

(Unit : mm)

### Features

- Non-hermetic package
- Chip Material : AlGaAs
- Chip Dimension : 400um \* 400um
- Number of Chips : 2pcs
- Peak Wavelength: 770nm / 840nm typ.
- Stem: TO-18 3pin type
- Lens : Flat Glass
- CAP : Gold plated

### Application

## 770nm

### Absolute Maximum Ratings (Tc=25°C)

Item	Symbol	Ratings	Unit
Power Dissipation	PD	200	mW
Forward Current	IF	100	mA
Pulse Forward Current	IFP	500	mA
Reverse Voltage	VR	5	V
Thermal Resistance	Rthja	280	K/W
Junction Temperature	Tj	120	°C
Operating Temperature	Topr	-40 ~ +100	°C
Storage Temperature	Tstg	-40 ~ +100	°C
Soldering Temperature	TSOL	250	°C

‡Pulse Forward Current condition: Duty 1% and Pulse Width=10us.

‡Soldering condition: Soldering condition must be completed within 5 seconds at 250°C and is allowed in the area apart 3mm from the bottom of the lamp.

### Optical and Electrical Characteristics (Tc=25°C)

Parameter	Symbol	Min	Typ	Max	Unit	Test Condition
Forward Voltage	VF		1.8	2.0	V	IF=50mA
	VFP		3.8			IFP=500mA
Total Radiated Power	PO		10		mW	IF=50mA
			100			IFP=500mA
Peak Wavelength	$\lambda_p$	760		780	nm	IF=50mA
Half Width	$\Delta\lambda$		26		nm	IF=50mA
Rise Time	tr		10		ns	IF=50mA
Fall Time	tf		15		ns	IF=50mA

‡ Radiated Power is measured by S3584-08.

## 840nm

### Absolute Maximum Ratings (Tc=25°C)

Item	Symbol	Ratings	Unit
Power Dissipation	PD	180	mW
Forward Current	IF	100	mA
Pulse Forward Current	IFP	500	mA
Reverse Voltage	VR	5	V
Thermal Resistance	Rthja	280	K/W
Junction Temperature	Tj	120	°C
Operating Temperature	Topr	-40 ~ +100	°C
Storage Temperature	Tstg	-40 ~ +100	°C
Soldering Temperature	TSOL	250	°C

‡Pulse Forward Current condition: Duty 1% and Pulse Width=10us.

‡Soldering condition: Soldering condition must be completed within 5 seconds at 250°C and is allowed in the area apart 3mm from the bottom of the lamp.

### Optical and Electrical Characteristics (Tc=25°C)

Parameter	Symbol	Min	Typ	Max	Unit	Test Condition
Forward Voltage	VF		1.7	1.8	V	IF=50mA
	VFP		2.6			IFP=500mA
Total Radiated Power	PO		9		mW	IF=50mA
			89			IFP=500mA
Peak Wavelength	$\lambda_p$	830		850	nm	IF=50mA
Half Width	$\Delta\lambda$		33		nm	IF=50mA
Rise Time	tr		10		ns	IF=50mA
Fall Time	tf		15		ns	IF=50mA

‡ Radiated Power is measured by S3584-08.

Typical Characteristic Curves  
770nm

Forward Current - Forward Voltage

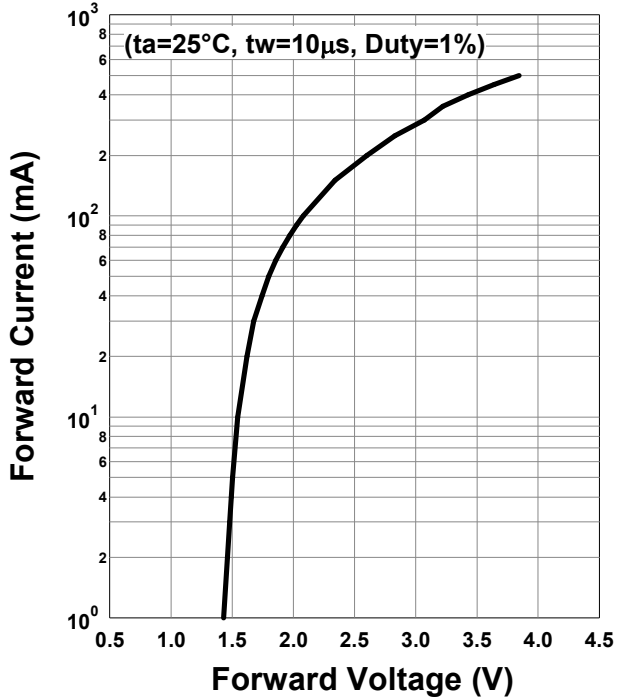

Relative Radiant Intensity - Forward Current

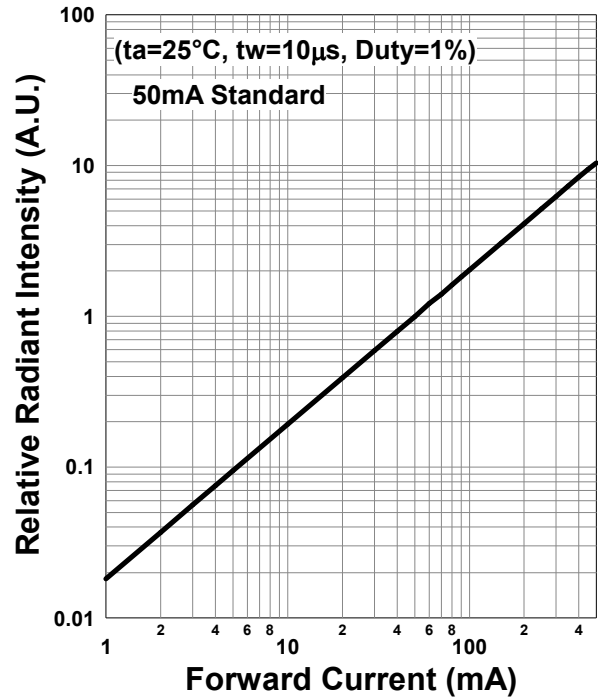

Forward Current - Pulse Duration

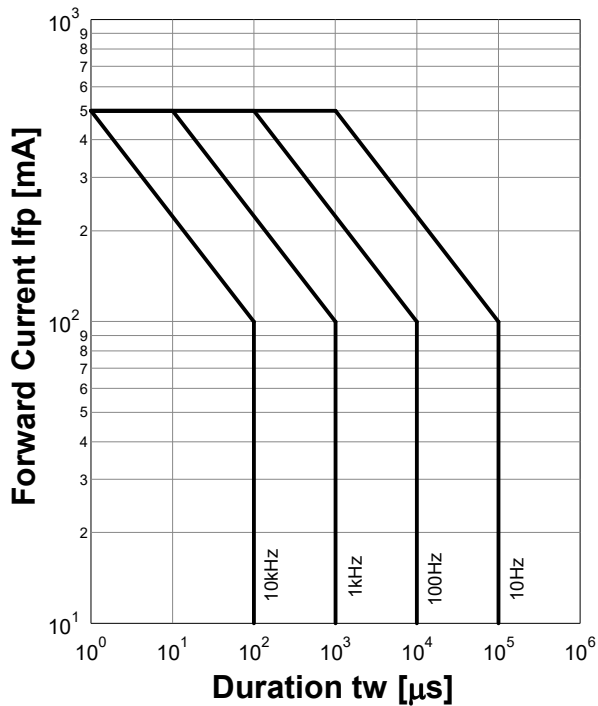

Allowable Forward Current - Ambient Temperature

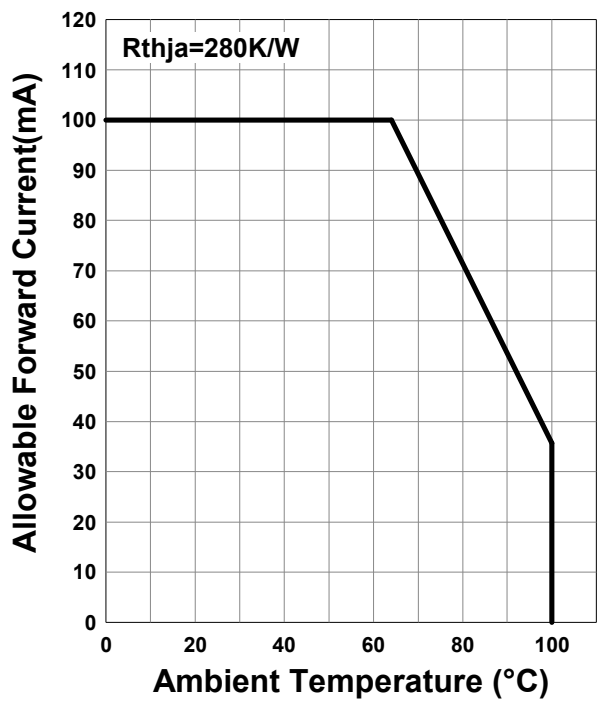

Data Sheet L770/840-40D54

770nm

**Forward Voltage - Ambient Temperature**

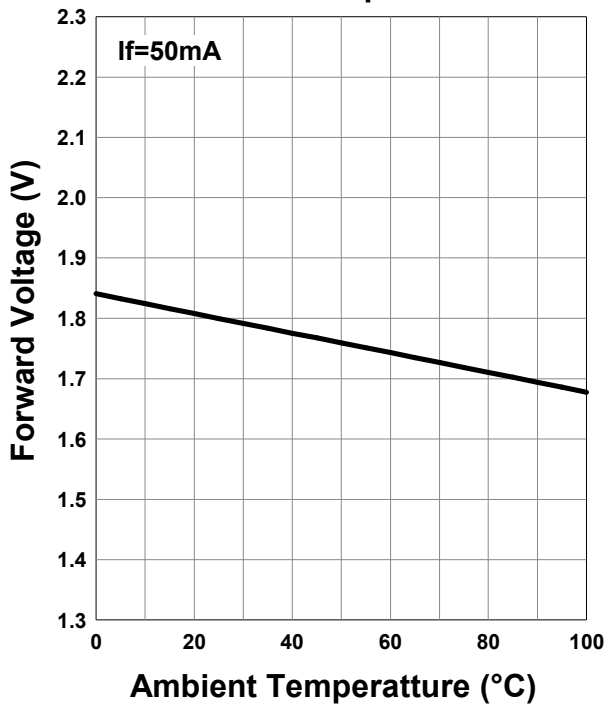

**Relative Radiant Intensity - Ambient Temperature**

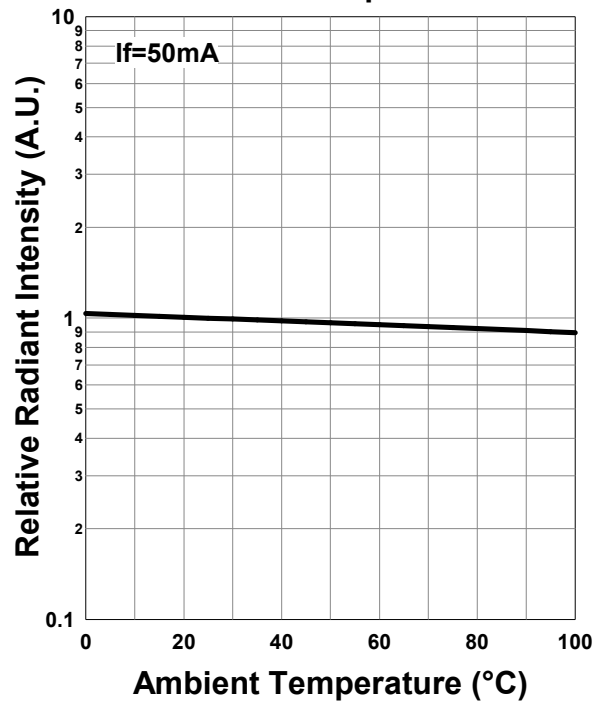

**Peak Wavelength - Ambient Temperature**

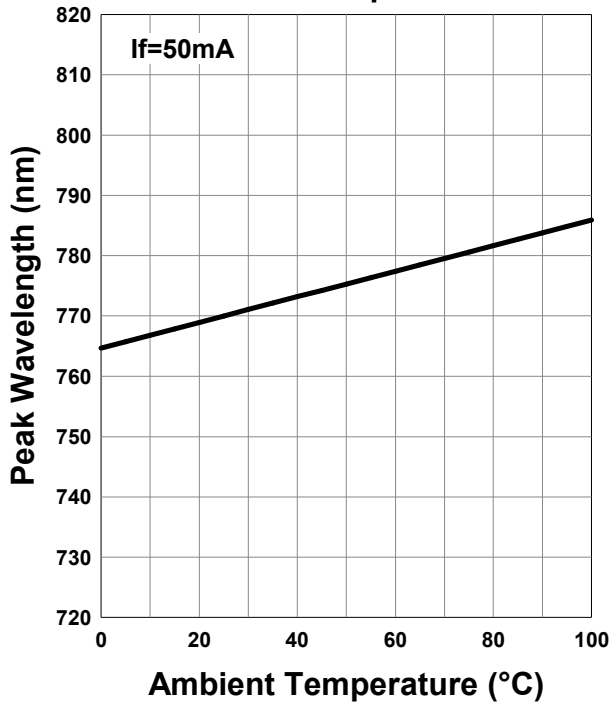

**Relative Spectral Emission**

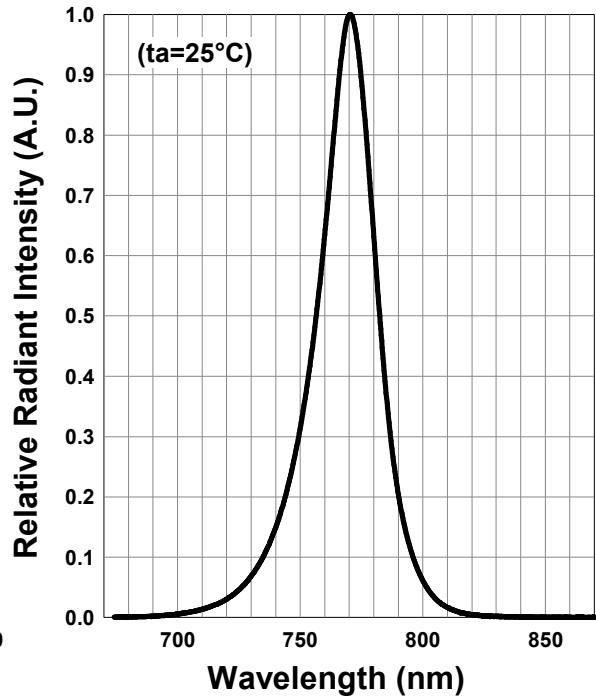

## Typical Characteristic Curves

### 840nm

#### Forward Current - Forward Voltage

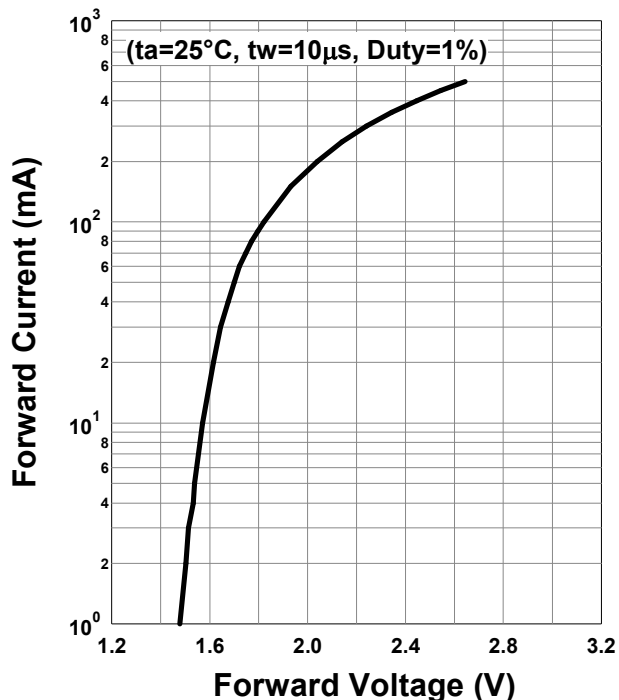

#### Relative Radiant Intensity - Forward Current

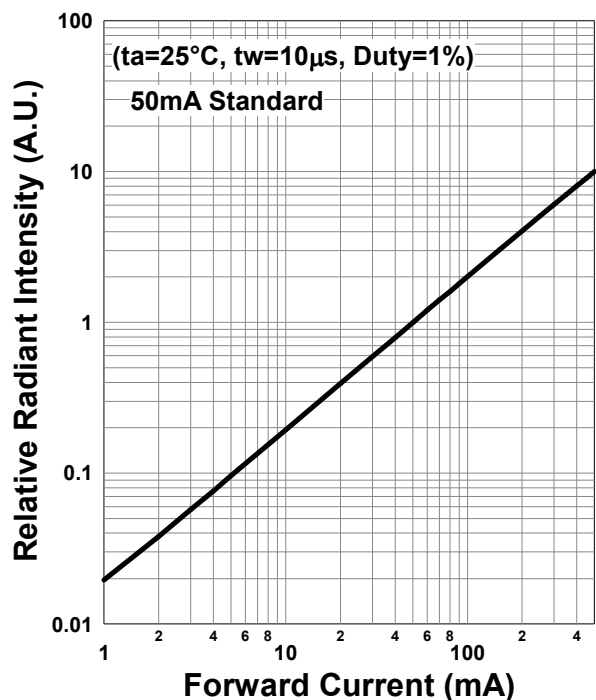

#### Forward Current - Pulse Duration

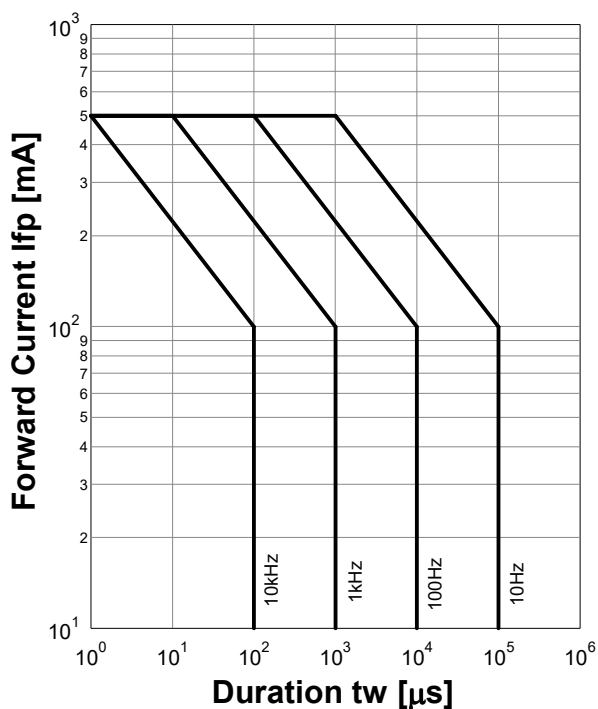

#### Allowable Forward Current - Ambient Temperature

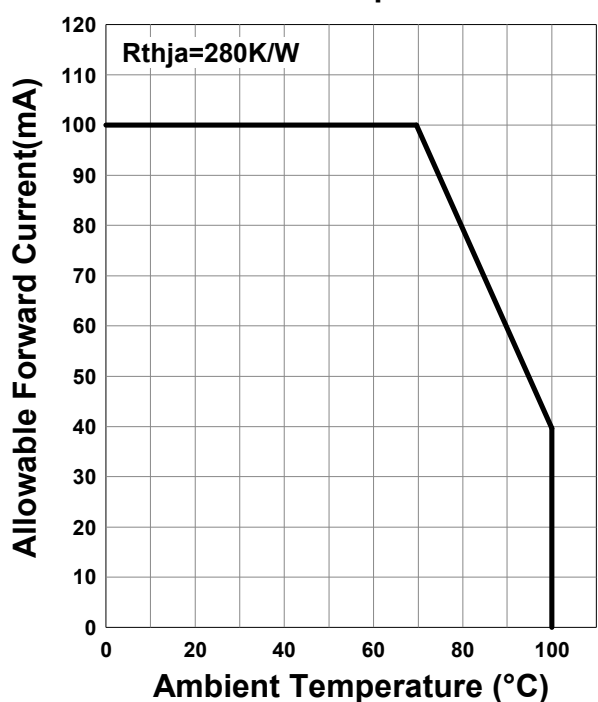

Data Sheet L770/840-40D54

840nm

**Forward Voltage - Ambient Temperature**

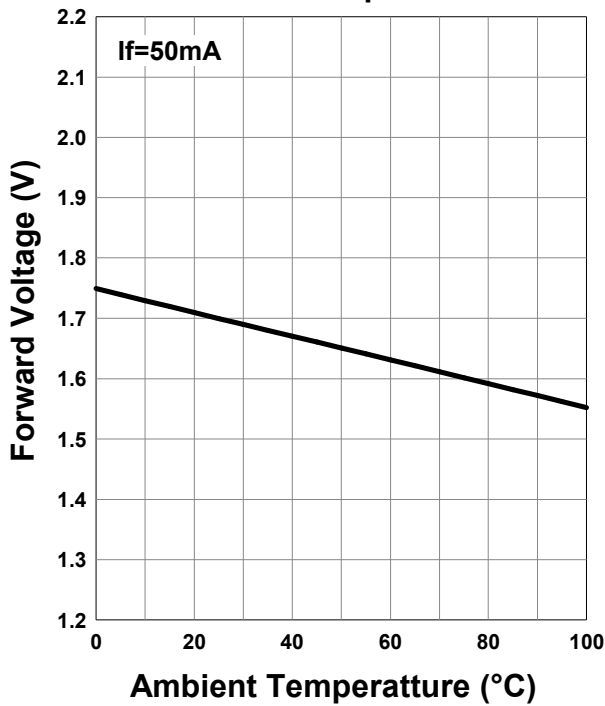

**Relative Radiant Intensity - Ambient Temperature**

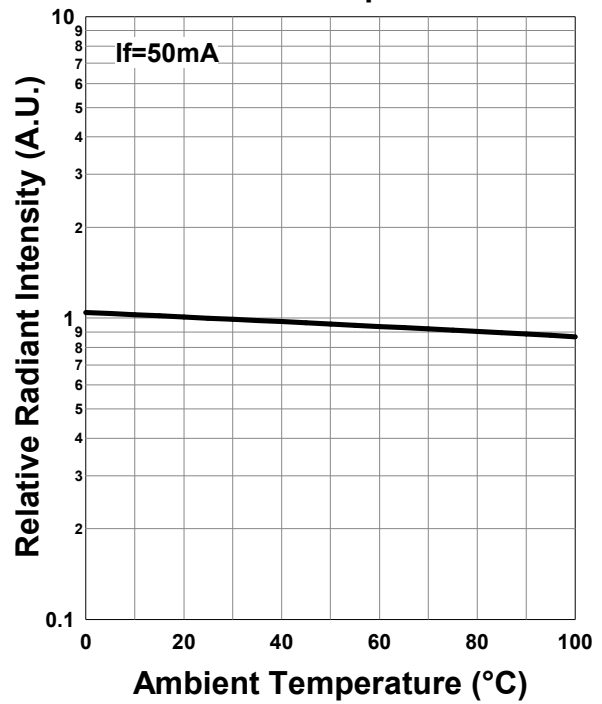

**Peak Wavelength - Ambient Temperature**

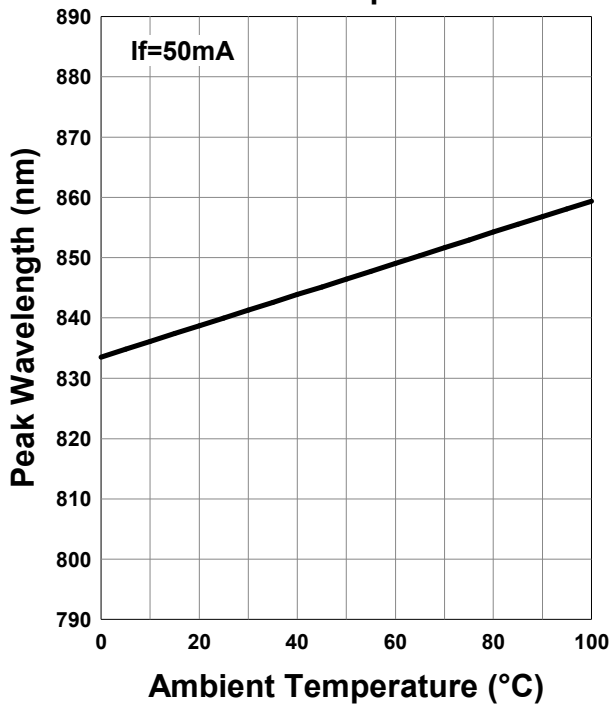

**Relative Spectral Emission**

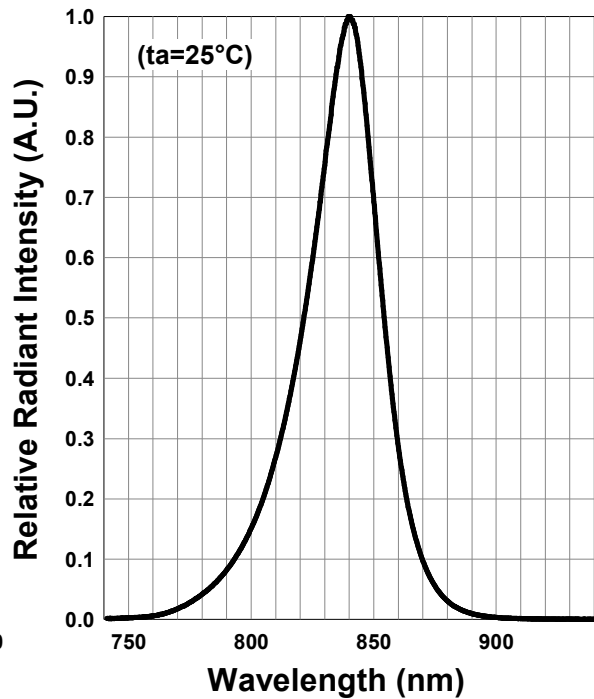

Data Sheet L770/840-40D54

## Disclaimer

Product specifications and data shown in this product catalog are subject to change without notice for the purposes of improving product performance, reliability, design, or otherwise.

Product data and parameters in this catalog are typical values based on reasonably up-to-date measurements.

Product data and parameters may vary by user application and over time.

Products shown in this catalog are intended to be used for general electronic equipment. Products are not guaranteed for applications where product malfunction or failure may cause personal injury or death, including but not limited to life-supporting / saving devices, medical devices, safety devices, airplanes, aerospace equipment, automobiles, traffic control systems, and nuclear reactor control systems.

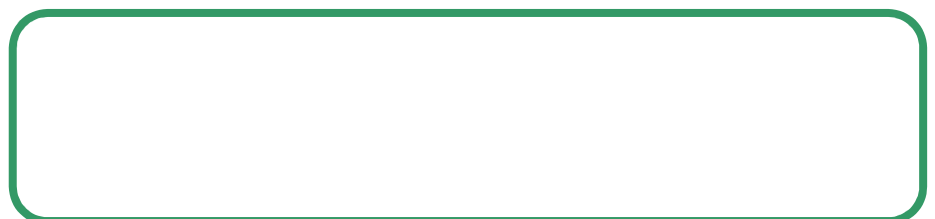

\*Effective July 2016, Ushio Epitex Inc. is now Ushio Opto Semiconductors, Inc.