

Data Sheet

L830-05AU

Infrared LED Lamp

USHIO

Outline and Internal Circuit

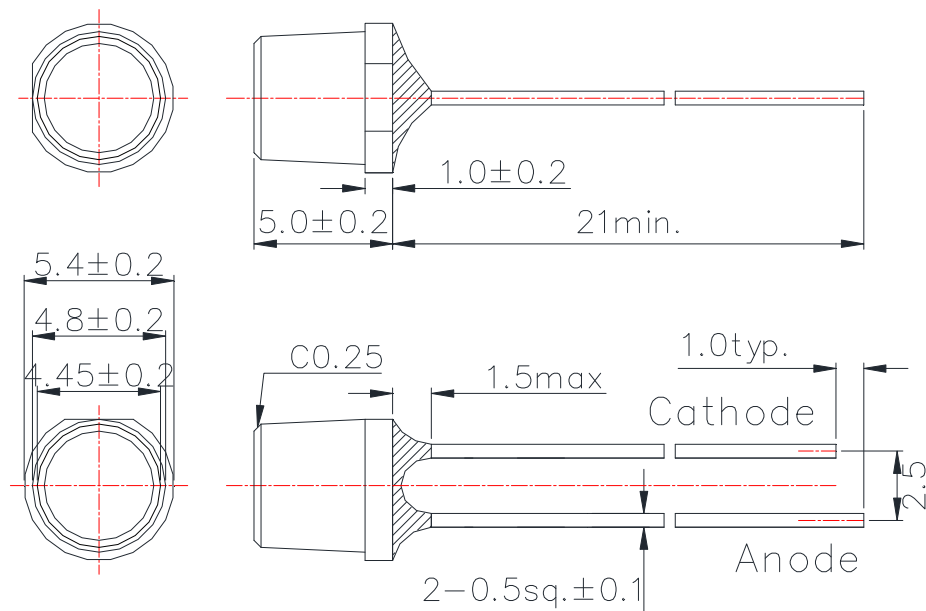

(Unit : mm)

Features

- Chip Material : AlGaAs
- Chip Dimension : $400\mu\text{m} * 400\mu\text{m}$
- Number of Chips : 1pc
- Peak Wavelength : 830nm typ.
- Package Type : $\phi 5\text{mm}$ clear molding
- Lead Frame : Soldered (Lead Free)
- Lens : Epoxy Resin

Application

Absolute Maximum Ratings (Tc=25°C)

Item	Symbol	Ratings	Unit
Power Dissipation	PD	180	mW
Forward Current	IF	100	mA
Pulse Forward Current	IFP	500	mA
Reverse Voltage	VR	5	V
Thermal Resistance	Rthja	180	K/W
Junction Temperature	Tj	120	°C
Operating Temperature	Topr	-40 ~ +100	°C
Storage Temperature	Tstg	-40 ~ +100	°C
Soldering Temperature	TSOL	265	°C

‡Pulse Forward Current condition : Duty 1% and Pulse Width=10us.

‡Soldering condition : Soldering condition must be completed with 3 seconds at 265°C.

Optical and Electrical Characteristics (Tc=25°C)

Parameter	Symbol	Min	Typ	Max	Unit	Test Condition
Forward Voltage	VF		1.6	1.8	V	IF=50mA
	VFP		2.7			IFP=500mA
Total Radiated Power	PO		20		mW	IF=50mA
			190			IFP=500mA
Radiant Intensity	IE		19		mW/sr	IF=50mA
			180			IFP=500mA
Peak Wavelength	λ_p	820		840	nm	IF=50mA
Half Width	$\Delta\lambda$		34		nm	IF=50mA
Viewing Half Angle	$\theta_{1/2}$		± 48		deg.	IF=50mA
Rise Time	tr		10		ns	IF=50mA
Fall Time	tf		20		ns	IF=50mA

‡ Radiated Power is measured by S3584-08.

‡ Radiant Intensity is measured by CIE127-2007 Condition B.

Typical Characteristic Curves

Forward Current - Forward Voltage

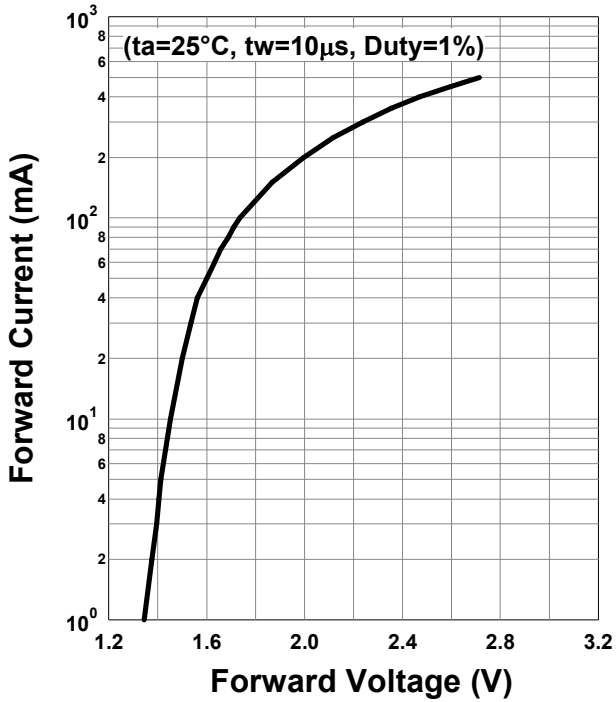

Relative Radiant Intensity - Forward Current

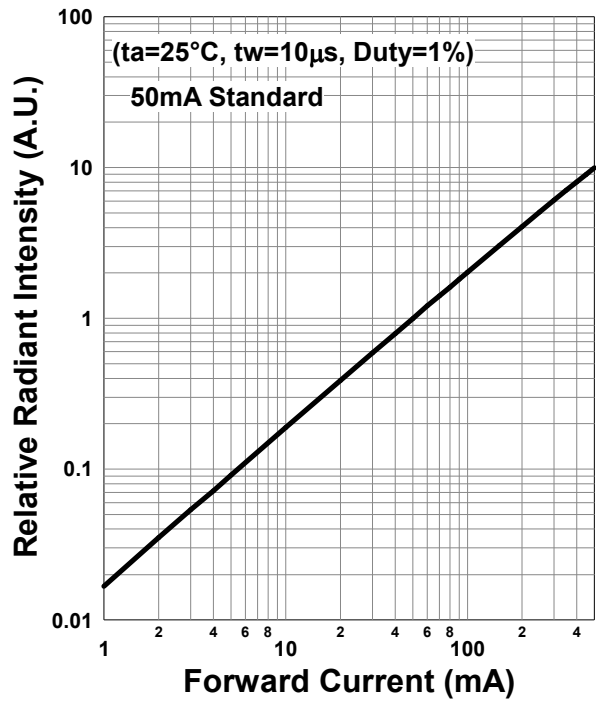

Forward Current - Pulse Duration

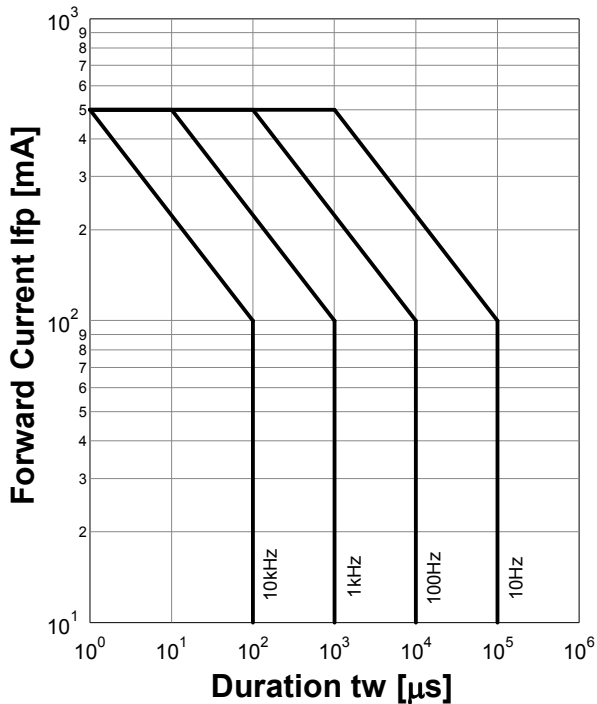

Allowable Forward Current - Ambient Temperature

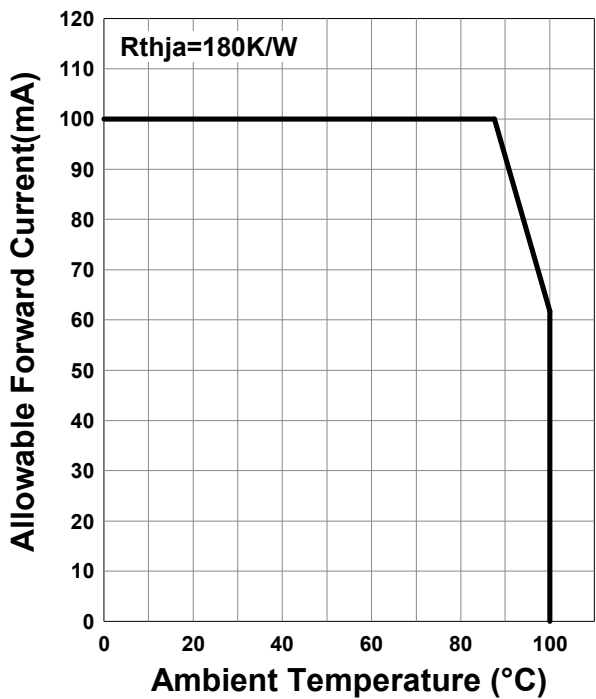

Forward Voltage - Ambient Temperature

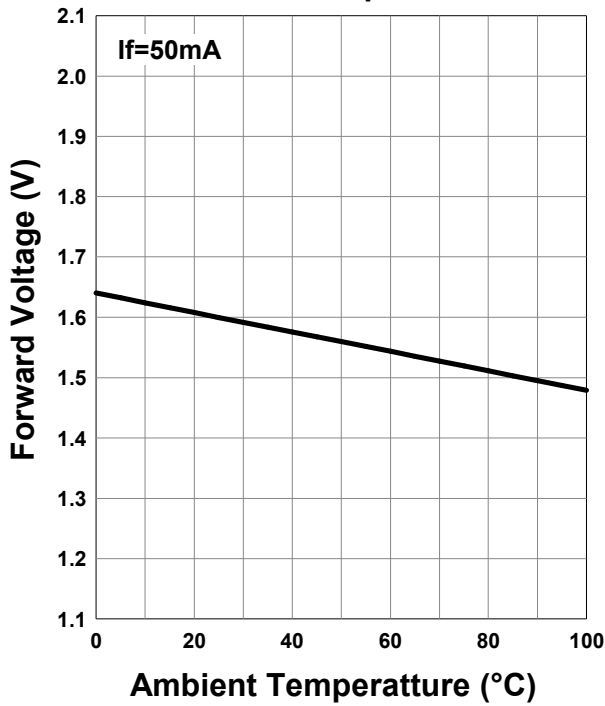

Relative Radiant Intensity - Ambient Temperature

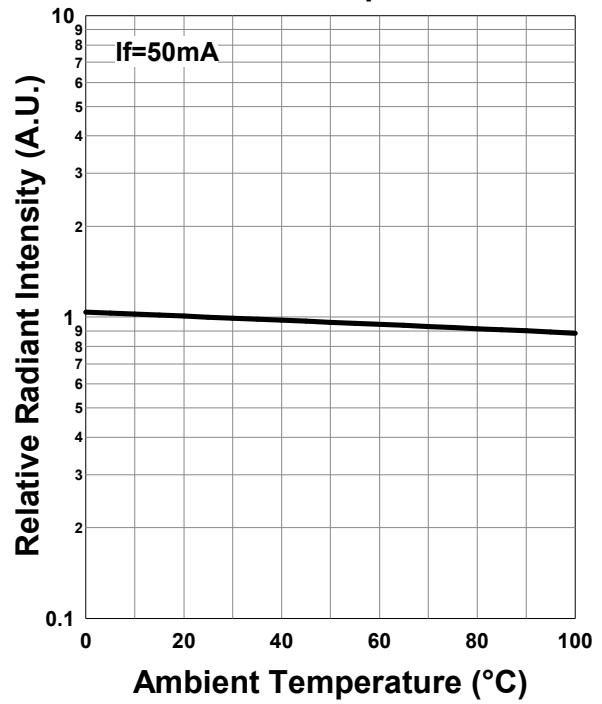

Peak Wavelength - Ambient Temperature

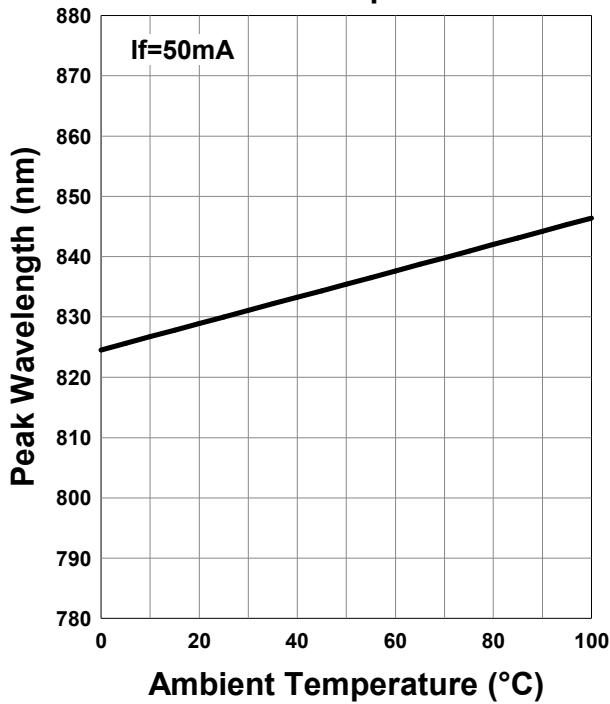

Relative Spectral Emission

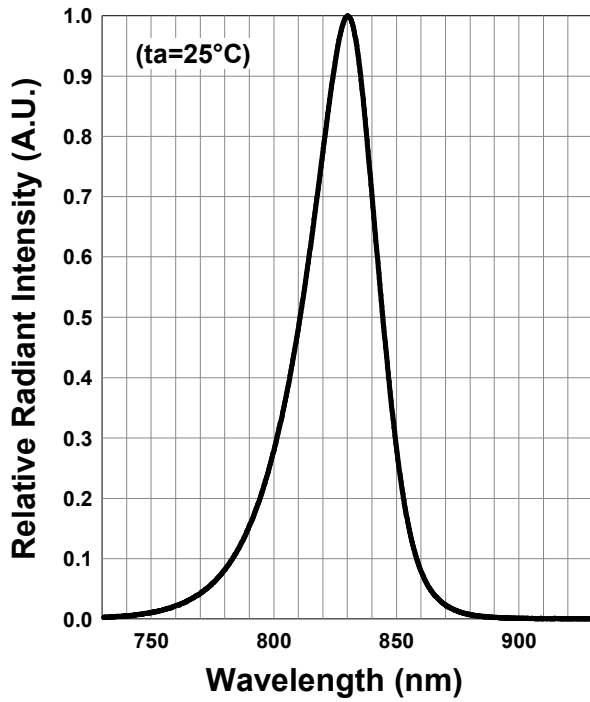

Radiation Characteristics

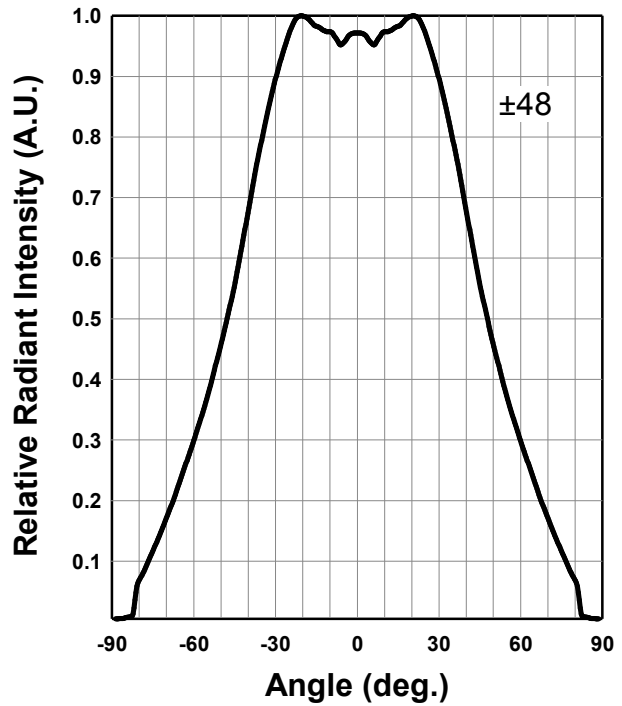

Radiation Characteristics

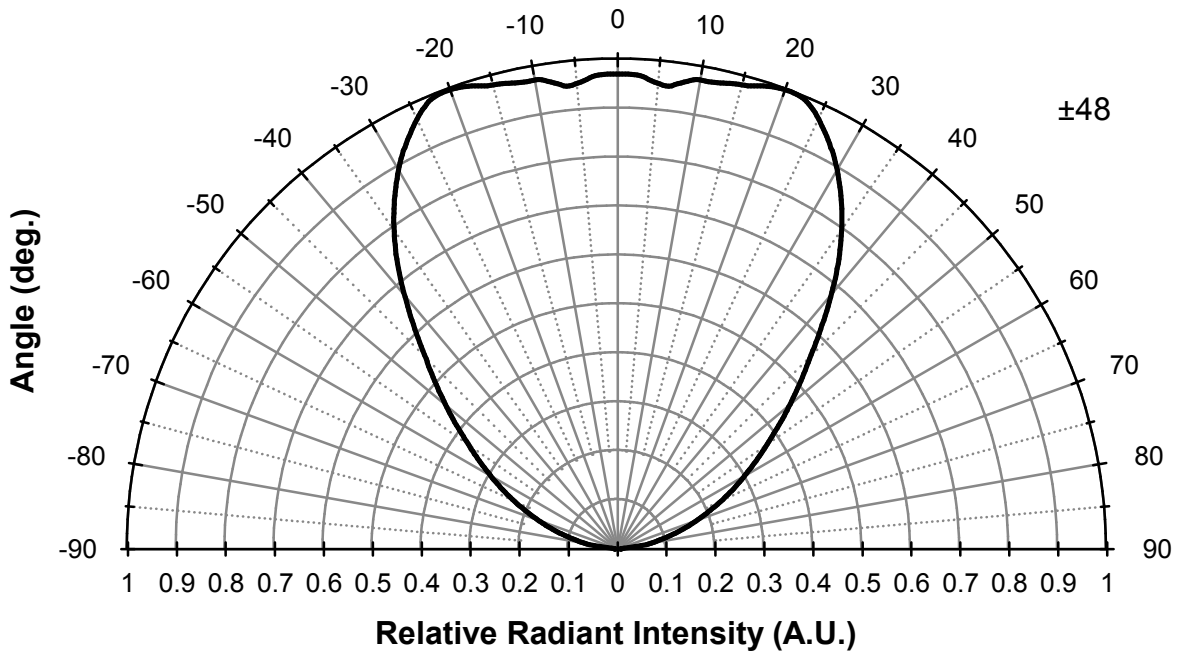

Disclaimer

Product specifications and data shown in this product catalog are subject to change without notice for the purposes of improving product performance, reliability, design, or otherwise.

Product data and parameters in this catalog are typical values based on reasonably up-to-date measurements.

Product data and parameters may vary by user application and over time.

Products shown in this catalog are intended to be used for general electronic equipment. Products are not guaranteed for applications where product malfunction or failure may cause personal injury or death, including but not limited to life-supporting / saving devices, medical devices, safety devices, airplanes, aerospace equipment, automobiles, traffic control systems, and nuclear reactor control systems.

*Effective July 2016, Ushio Epitex Inc. is now USHIO OPTO SEMICONDUCTORS, INC.