

Data Sheet

PRELIMINARY

L680-04AU

Infrared LED Lamp

USHIO

Outline and Internal Circuit

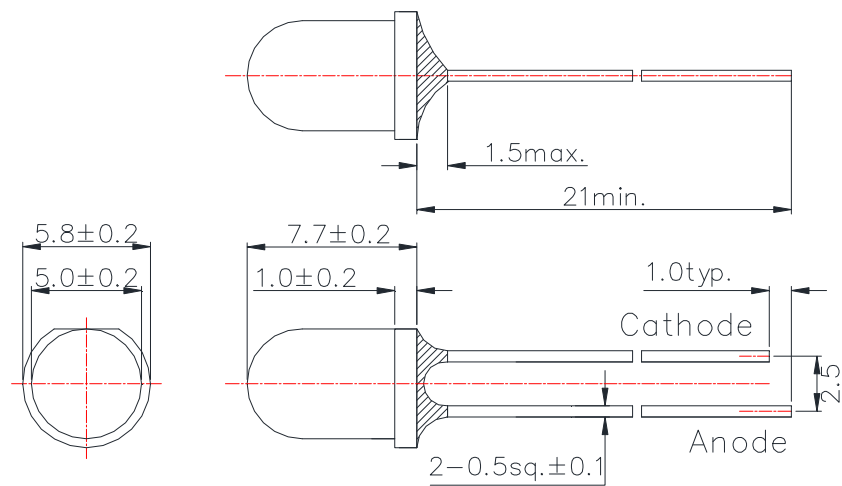

(Unit : mm)

Features

- Chip Material : AlGaAs
- Chip Dimension : $350 \mu\text{m} * 350 \mu\text{m}$
- Number of Chips : 1pce
- Peak Wavelength : 680 nm typ.
- Package Type : $\phi 5 \text{ mm}$ clear molding
- Lead Frame : Soldered (Lead Free)
- Lens : Epoxy Resin

Application

Absolute Maximum Ratings (Tc=25°C)

| Item | Symbol | Ratings | Unit |
|-----------------------|--------|------------|------|
| Power Dissipation | PD | 120 | mW |
| Forward Current | IF | 50 | mA |
| Pulse Forward Current | IFP | 200 | mA |
| Reverse Voltage | VR | 5 | V |
| Thermal Resistance | Rthja | 220 | K/W |
| Junction Temperature | Tj | 120 | °C |
| Operating Temperature | Topr | -40 ~ +100 | °C |
| Storage Temperature | Tstg | -40 ~ +100 | °C |
| Soldering Temperature | TSOL | 265 | °C |

‡Pulse Forward Current condition : Duty 1% and Pulse Width=10us.

‡Soldering condition : Soldering condition must be completed with 3 seconds at 265°C.

Optical and Electrical Characteristics (Tc=25°C)

| Parameter | Symbol | Min | Typ | Max | Unit | Test Condition |
|----------------------|-----------------|-----|----------|-----|-------|-------------------|
| Forward Voltage | VF | | 1.8 | 2.3 | V | IF=20mA |
| | | | 2.0 | | | IF=50mA T=20ms |
| | VFP | | 2.8 | | | IFP=200mA |
| Total Radiated Power | PO | | 5.8 | | mW | IF=20mA |
| | | | 16 | | | IF=50mA T=20ms |
| | | | 67 | | | IFP=200mA |
| Radiant Intensity | IE | | 22 | | mW/sr | IF=20mA |
| | | | 61 | | | IF=50mA T=20ms |
| | | | 250 | | | IFP=200mA |
| Peak Wavelength | λ_p | 670 | | 690 | nm | IF=20mA |
| Half Width | $\Delta\lambda$ | | 24 | | nm | IF=20mA |
| Viewing Half Angle | $\theta_{1/2}$ | | ± 16 | | deg. | IF=20mA |
| Rise Time | tr | | 10 | | ns | IF=20mA |
| Fall Time | tf | | 10 | | ns | IF=20mA |

‡ Radiated Power is measured by S3584-08.

‡ Radiant Intensity is measured by CIE127-2007 Condition B.

Typical Characteristic Curves

Forward Current - Forward Voltage

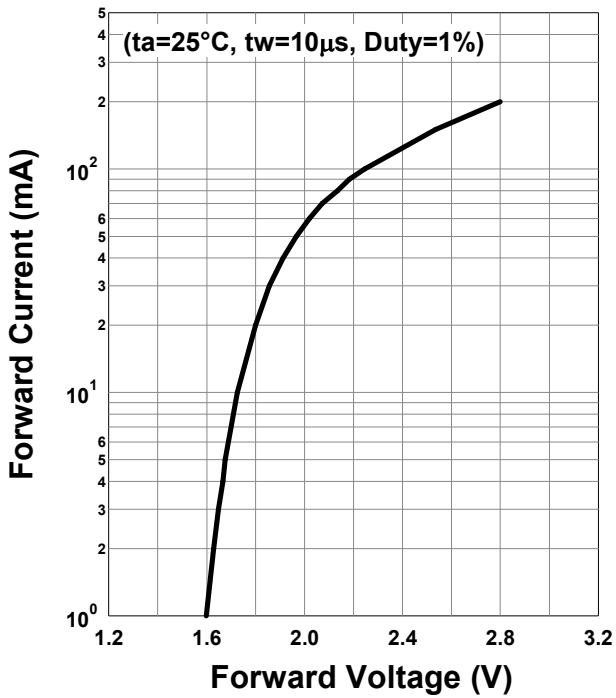

Relative Radiant Intensity - Forward Current

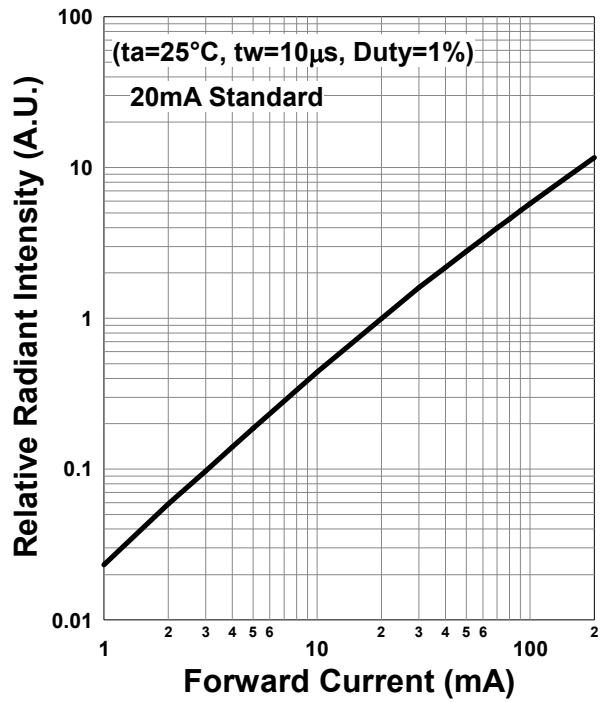

Forward Current - Pulse Duration

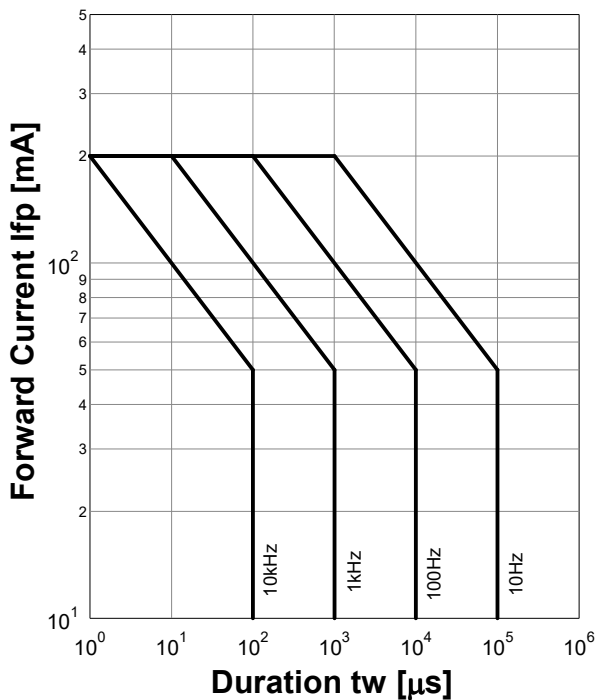

Allowable Forward Current - Ambient Temperature

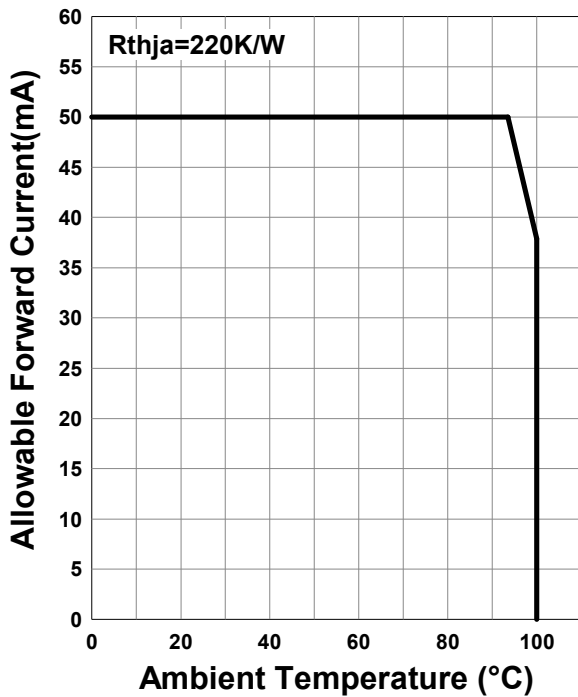

Forward Voltage - Ambient Temperature

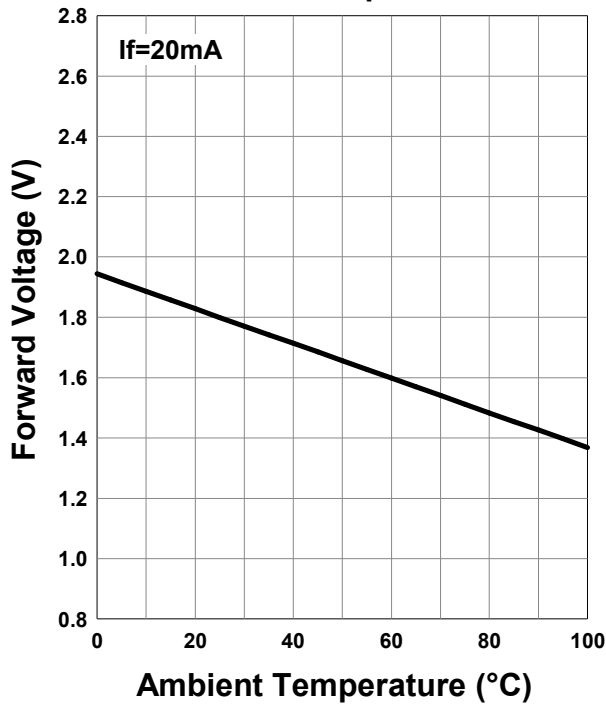

Relative Radiant Intensity - Ambient Temperature

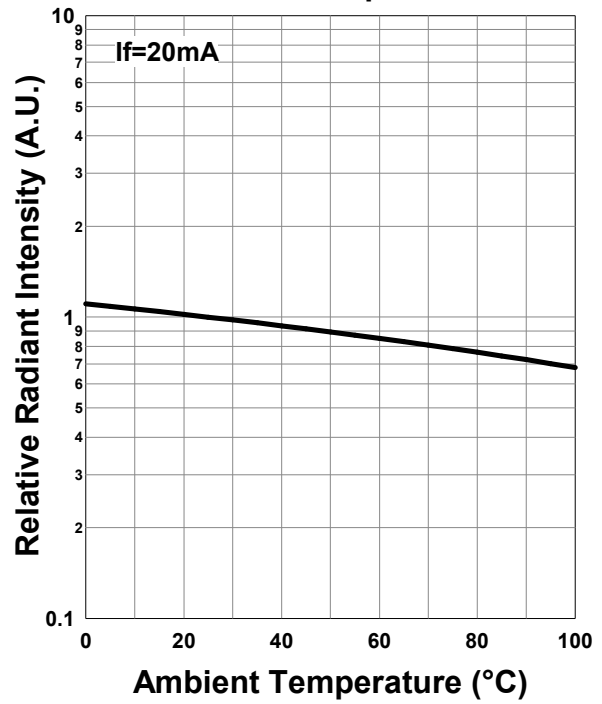

Peak Wavelength - Ambient Temperature

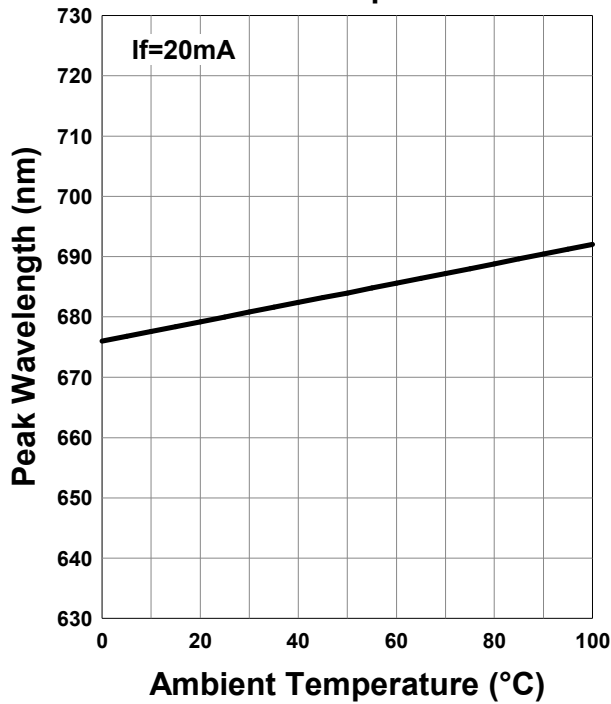

Relative Spectral Emission

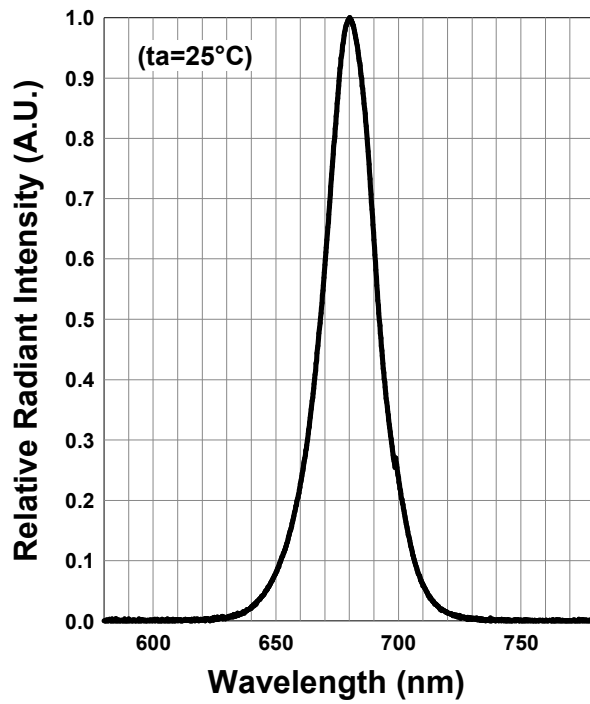

Radiation Characteristics

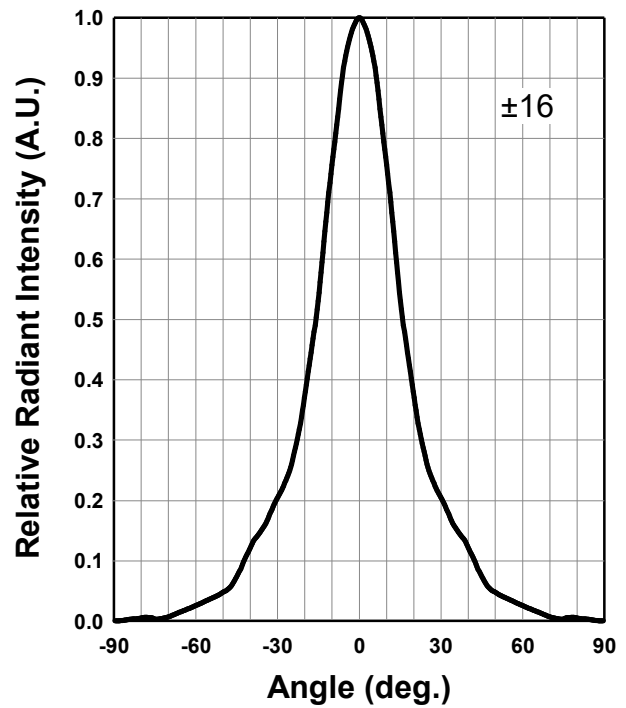

Radiation Characteristics

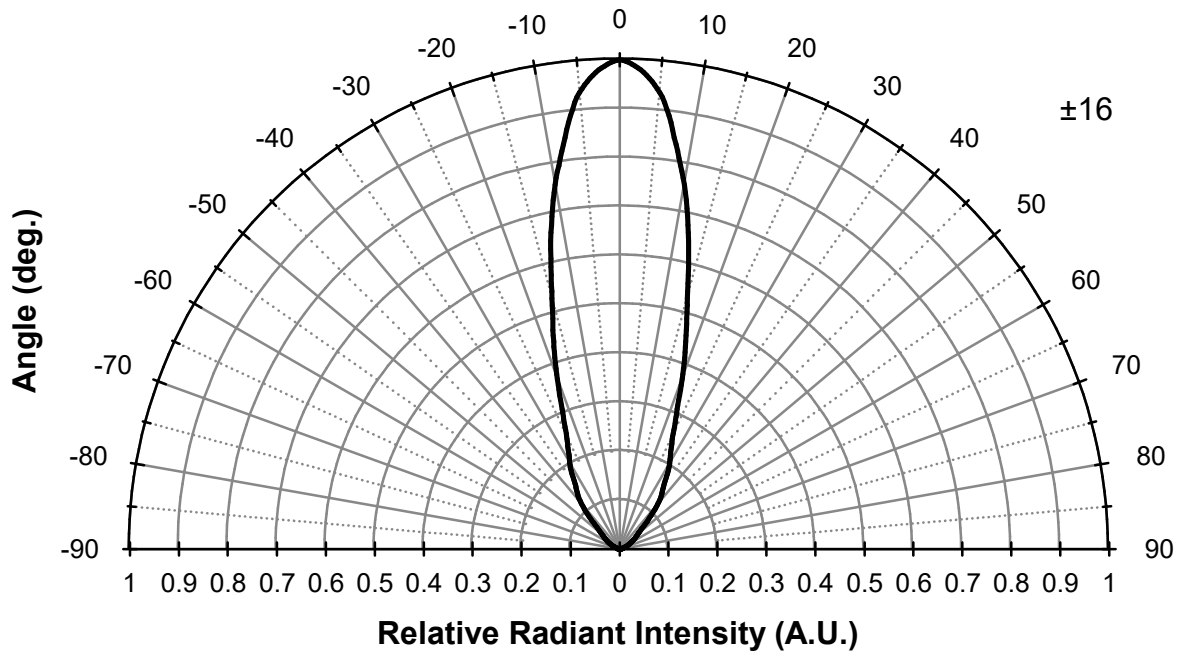

Disclaimer

Product specifications and data shown in this product catalog are subject to change without notice for the purposes of improving product performance, reliability, design, or otherwise.

Product data and parameters in this catalog are typical values based on reasonably up-to-date measurements.

Product data and parameters may vary by user application and over time.

Products shown in this catalog are intended to be used for general electronic equipment. Products are not guaranteed for applications where product malfunction or failure may cause personal injury or death, including but not limited to life-supporting / saving devices, medical devices, safety devices, airplanes, aerospace equipment, automobiles, traffic control systems, and nuclear reactor control systems.



*Effective July 2016, Ushio Epitex Inc. is now USHIO OPTO SEMICONDUCTORS, INC.